

UNIFON ANALOGOWY DO SYSTEMU 4+N
NR REF. 1150

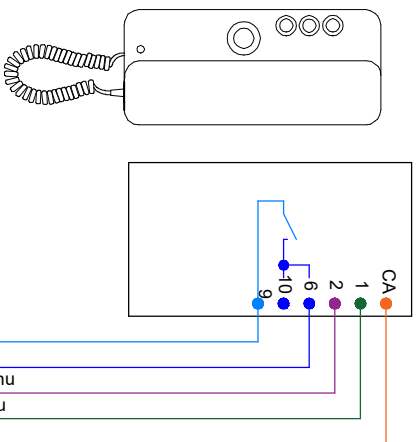

LEGENDA

Unifony :
nr ref. 1150, nr ref. 1150/1,
nr ref. 1132, nr ref. 1132/1,
nr ref. 1131, nr ref. 1131/1
nr ref. 1140/1, 1140/4/1

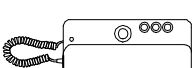

Zasilacz domofonowy
NR REF. 18K1 (6DIN)

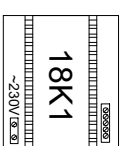

Panel wywołania w linii stylistycznej
SINTHESI
Płyta różnówna 1148/21, moduł 1145/500
Puszka podtylnkowa 1145/511 ranka
frontowa 1146/61

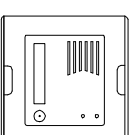

Elektrozaczep NC 12V AC



Przycisk wyjścia (np H300)

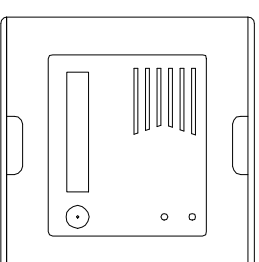
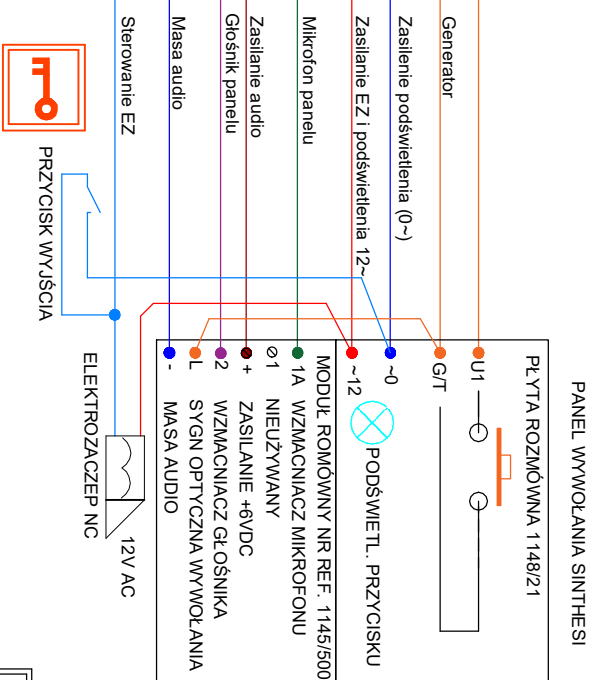
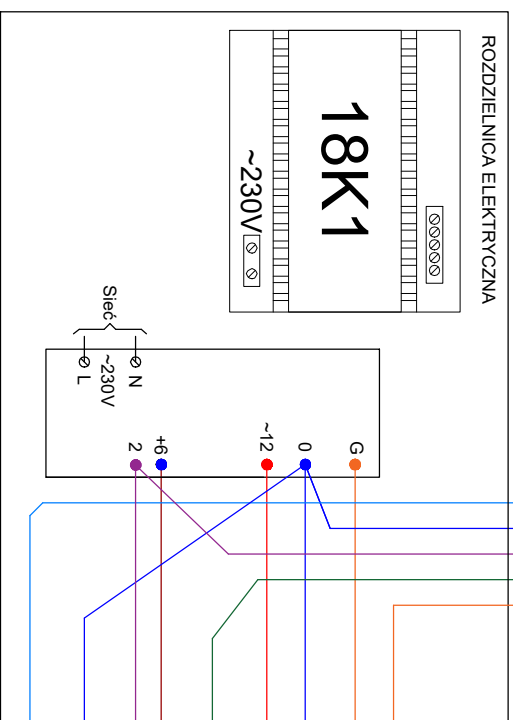

Opis:
SD_4N_11_18K1_1145_500_SET1-MIRO

System:
4+N

Wykonat:
MIWI-URMET/RA

Dia:
MIWI URMET

Numer schematu:
SD 4n 18K1 SET1