

UNIFON ANALOGOWY DO SYSTEMU 4+N
NR REF. 1150

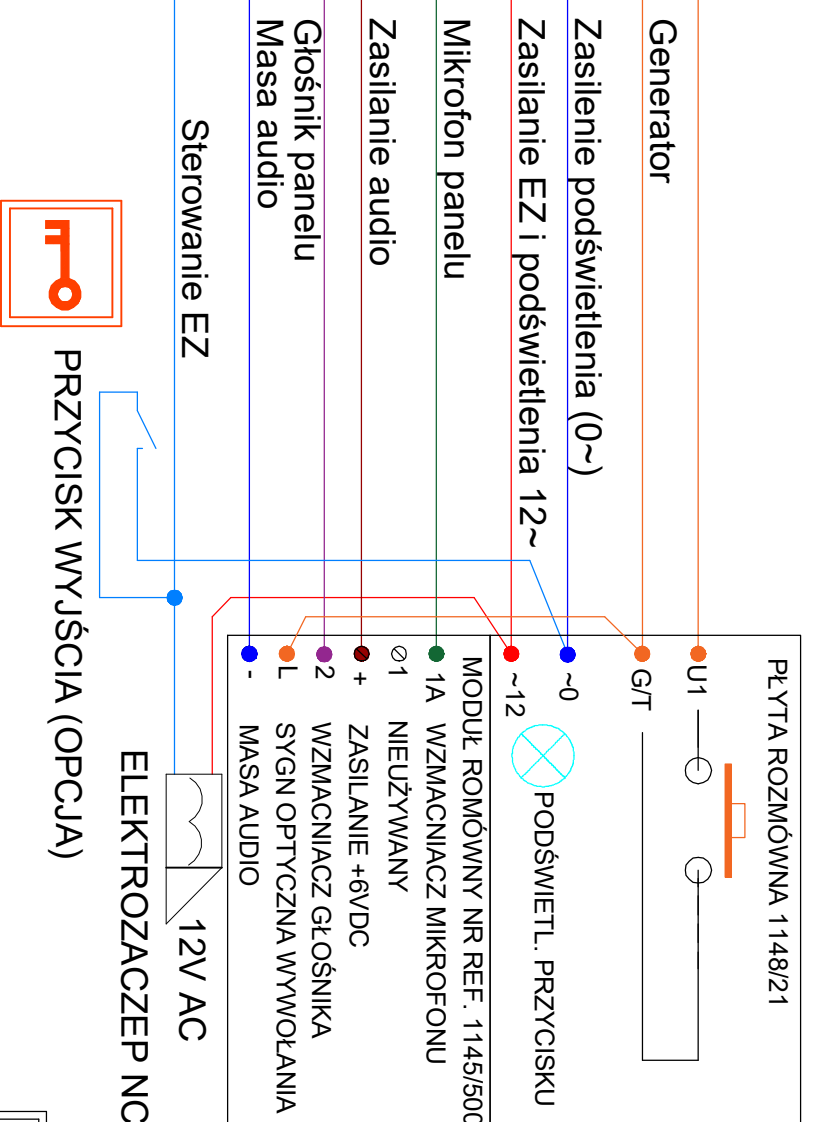

PRZYCISK WYJŚCIA (OPCJA)

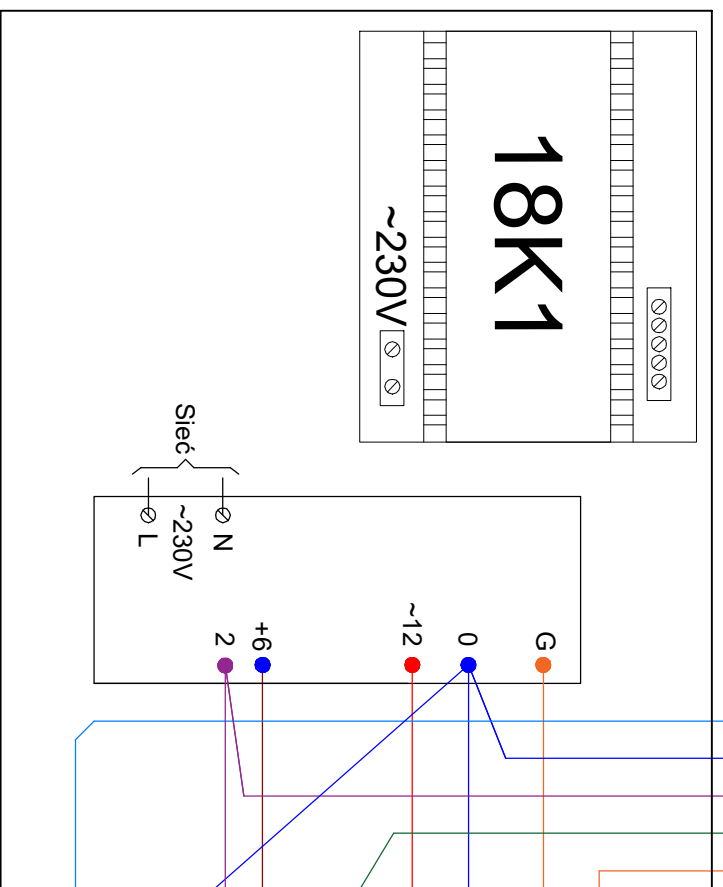
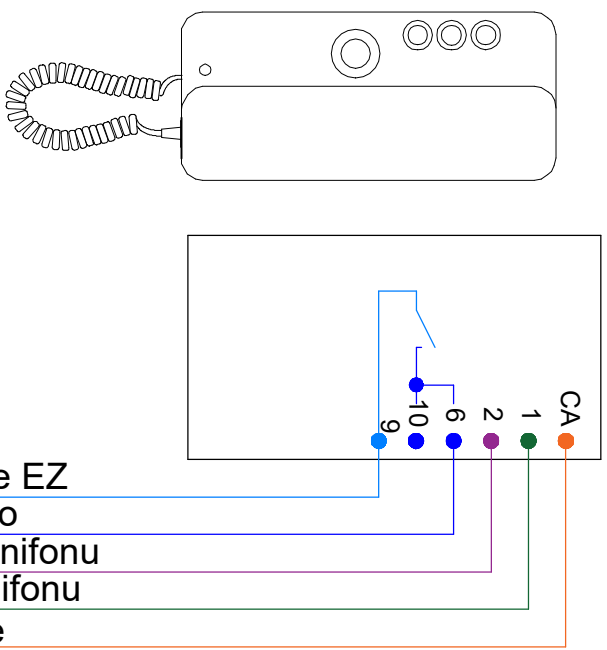

PANEL WYWOŁANIA SINTHESI

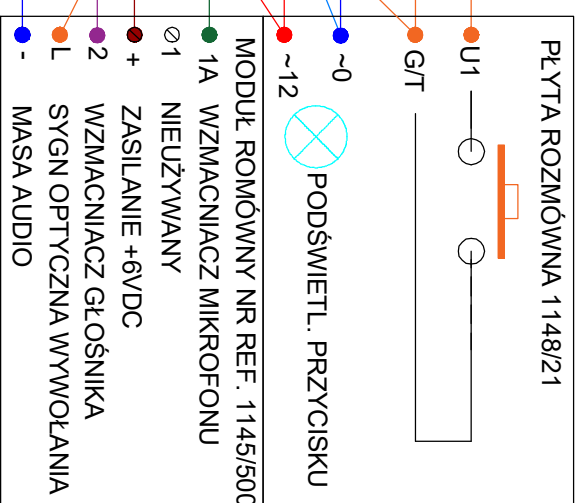

Przycisk wyjścia (np H300)

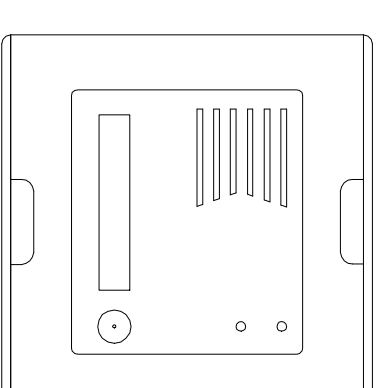

LEGENDA

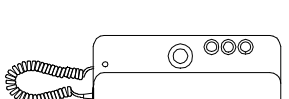

Unifony :
nr ref. 1150, nr ref. 1150/1,
nr ref. 1132, nr ref. 1132/1,
nr ref. 1131, nr ref. 1131/1
nr ref. 1140/1, 1140/4/1

Zasilacz domofonowy
NR REF. 18K1 (7DIN)

Panel wywołania w linii
stylistycznej SINTHESI

Płyta rozmówna 1148/21, moduł
1145/500

Puszka podtynkowa 1145/51
i ramka frontowa 1148/61

Elektrozaczep NC 12V AC

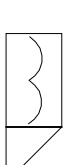

| | | | |
|---|--|------------------------------------|--|
| Opis: SD_4N_11_18K1_1145_500_SET1-MIRO | | System: 4+N | |
| Wykonat: MIWI-URMET/RA | | Numer schematu: SD 4n 18K1 SET1 | |
| Dla: MIWI URMET | | | |